





13 415 979



- Ausladung 150 mm
- CASCADE, Durchfluss max. 26,5 l/min (bei 3 Bar)
- Abdeckplatte 240 x 60 mm
- Anschluss 1/2"
- Steckanschluss-Montage

Passt zu: IMO, LULU, MADISON, MEM, TARA, CL.1, LISSÉ, VAIA, META, CYO

	Light Gold gebürstet	13 415 979-27
	Chrom	13 415 979-00
	Platin gebürstet	13 415 979-06
	Platin	13 415 979-08
	Dark Chrome	13 415 979-19
	Light Gold	13 415 979-26
	Messing gebürstet (23kt Gold)	13 415 979-28
	Schwarz matt	13 415 979-33
	Bronze gebürstet	13 415 979-42
	Champagne gebürstet (22kt Gold)	13 415 979-46
	Champagne (22kt Gold)	13 415 979-47
	Chrom gebürstet	13 415 979-93
	Dark Platinum gebürstet	13 415 979-99

Empfohlenes Zubehör

	UP-Wandwinkel - •Min. Einbautiefe 90 mm •Max. Einbautiefe 163 mm	35 085 970 90
---	---	---------------

Empfohlenes Zubehör

	UP-Wandwinkel - •Min. Einbautiefe 90 mm •Max. Einbautiefe 163 mm	35 085 970 90
---	---	---------------

13 415 979

mm [inches]

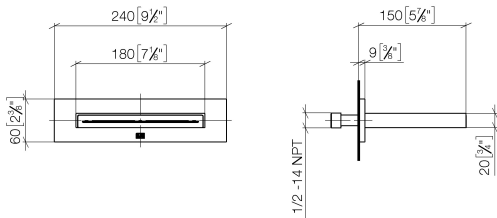

Durchflussdiagramm

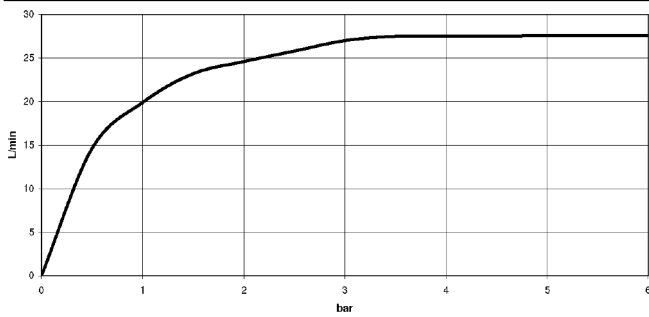

Wurfweitendiagramm

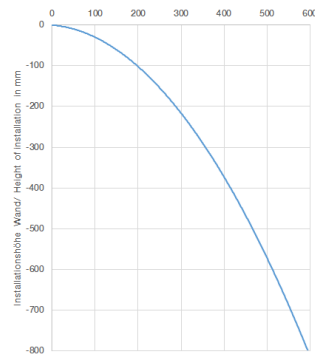

Zertifikate

WRAS_2306001.

13 415 979

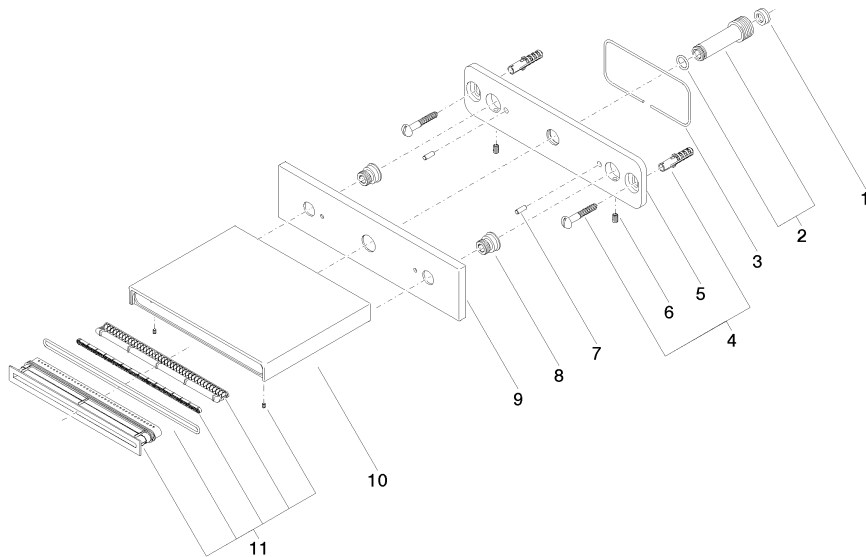

Ersatzteilstückliste

Nr.	Artikelnummer	Benennung	Verbaumenge	Lieferzeit
1	09 23 01 057 90	Durchflussbegrenzer	1	2
2	90 24 03 213 00 90	Anschluss	1	2
3	09 14 03 134 90	Dichtung	1	2
4	04 30 31 024 01 90	Befestigungssatz	1	2
5	09 17 97 059 90	Halter	1	2
6	09 31 11 036 90	Stift	2	2
7	09 31 11 040 90	Stift	2	2
8	09 24 03 214 90	Nippel	2	2
9	09 27 78 031-27	Rosette	1	60
10	09 11 78 003 20-27	Auslauf	1	60
11	90 29 03 059 00 90	Einsatz	1	2